

SPLIT TYPE

GREEN SOURCE AIR / AIR HEAT PUMP

OPERATION MANUAL

ENERGI



KLASS

Energy Class A

Uses New Refrigerant R410A

Must be installed by a qualified refrigerant engineer

INDOOR UNIT

OUTDOOR UNIT

WAAIU5

WAAOU5

Part NO.7 716 192 597

Part NO.7 716 192 598



* Plasmacluster is a trademark of SHARP Corporation.

BUILDING REGULATIONS

This appliance must be installed and serviced only by a competent person in accordance with the current: IEE Regulations, Building Regulation, Building Standards (Scotland) (Consolidation), Building Regulations (Northern Ireland) local water by-laws, Health & Safety Document 63S (The Electricity at Work Regulations 1989), IS 813 (Eire) and other local requirements.

The relevant Standards should be followed, including:

BS EN 14511: Requirements heat pumps for space heating and cooling

BS EN 378: Safety and environmental requirements for heat pumps

BS EN 14324 Brazing

BS 1306 Specification for copper & copper Alloy pressure piping system

The Health and Safety at Work Act 1974

The Management of Health and Safety at Work Regulations 1999

The Construction (Health, Safety and Welfare) Regulations 1996

The Construction (Design and Management) Regulations 1994

The Lifting Operations and Lifting Equipment Regulations 1998

Where no specific instructions is given, reference should be made to the relevant codes of Practice.



Attention: Your product is marked with this symbol. It means that used electrical and electronic products should not be mixed with general household waste. There is a separate collection system for these products.

A. Information on Disposal for Users (private households)

1. In the European Union

Attention: If you want to dispose of this equipment, please do not use the ordinary dust bin!

Used electrical and electronic equipment must be treated separately and in accordance with legislation that requires proper treatment, recovery and recycling of used electrical and electronic equipment.

Following the implementation by member states, private households within the EU states may return their used electrical and electronic equipment to designated collection facilities free of charge*. In some countries* your local retailer may also take back your old product free of charge if you purchase a similar new one.

*) Please contact your local authority for further details.

If your used electrical or electronic equipment has batteries or accumulators, please dispose of these separately beforehand according to local requirements.

By disposing of this product correctly you will help ensure that the waste undergoes the necessary treatment, recovery and recycling and thus prevent potential negative effects on the environment and human health which could otherwise arise due to inappropriate waste handling.

2. In other Countries outside the EU

If you wish to discard this product, please contact your local authorities and ask for the correct method of disposal.

For Switzerland: Used electrical or electronic equipment can be returned free of charge to the dealer, even if you don't purchase a new product. Further collection facilities are listed on the homepage of www.swico.ch or www.sens.ch.

B. Information on Disposal for Business Users.

1. In the European Union

If the product is used for business purposes and you want to discard it:

Please contact your WORCESTER dealer who will inform you about the take-back of the product. You might be charged for the costs arising from take-back and recycling.

Small products (and small amounts) might be taken back by your local collection facilities.

For Spain: Please contact the established collection system or your local authority for take-back of your used products.

2. In other Countries outside the EU

If you wish to discard of this product, please contact your local authorities and ask for the correct method of disposal.



Pb

The battery supplied with this product contains traces of Lead.

For EU: The crossed-out wheeled bin implies that used batteries should not be put to the general household waste!

There is a separate collection system for used batteries, to allow proper treatment and recycling in accordance with legislation. Please contact your local authority for details on the collection and recycling schemes.

For Switzerland: The used battery is to be returned to the selling point.

For other non-EU countries: Please contact your local authority for correct method of disposal of the used battery.

Contains fluorinated greenhouse gases covered by the Kyoto Protocol R410A (Global warming potential 1980)

CONTENTS

• IMPORTANT SAFETY INSTRUCTIONS	1
• PART NAMES	2
• USING THE REMOTE CONTROL	4
• SETTING AIR PURIFYING FILTER	5
• TIPS ON SAVING ENERGY	5
• AUXILIARY MODE	5
• BASIC OPERATION	6
• ADJUSTING THE AIR FLOW DIRECTION	7
• PROGRESSIVE AIRFLOW	8
• FULL POWER OPERATION	8
• PLASMACLUSTER OPERATION	9
• SELF CLEAN OPERATION	9
• ONE-HOUR OFF TIMER	10
• TIMER OPERATION	10
• 10°C OPERATION	12
• ADDITIONAL NOTES ON OPERATION	12
• MAINTENANCE	13
• BEFORE CALLING FOR SERVICE	14

IMPORTANT SAFETY INSTRUCTIONS

WARNINGS FOR USE

- 1** Do not pull or deform the power supply cord. Pulling and misuse of the power supply cord can result in damage to the unit and cause electrical shock.
- 2** Be careful not to expose your body directly to the outlet air for a long time. It may affect your physical conditions.
- 3** When using the air conditioner for infants, children, elderly, bedridden, or disabled people make sure the room temperature is suitable for those in the room.
- 4** Never insert objects into the unit. Inserting objects can result in injury due to the high speed rotation of internal fans.
- 5** Ground the air conditioner without fail. Do not connect the grounding wire to gas pipe, water pipe, lightning rod or telephone grounding wire. Incomplete grounding may cause electric shock.
- 6** If anything is abnormal with the air conditioner (ex. a burning smell), stop the operation immediately and turn the circuit breaker OFF.
- 7** The appliance shall be installed in accordance with national wiring regulations. Improper cable connection can cause the power supply cord, plug and the electrical outlet to overheat and cause fire.
- 8** If the supply cord is damaged, it must be replaced by the manufacturer or its service agent or a similarly qualified person in order to avoid a hazard. Use only the manufacture-specified power cord for replacement.

IMPORTANT SAFETY INSTRUCTIONS

WARNINGS FOR INSTALLATION/REMOVAL/REPAIR

- Do not attempt to install/remove/repair the unit by yourself. Incorrect work will cause electric shock, water leak, fire etc. Consult your dealer or other qualified service personnel for the installation/removal/repair of the unit.

CAUTIONS FOR USE

- 1** Open a window or door periodically to ventilate the room, especially when using gas appliances. Insufficient ventilation may cause oxygen shortage.
- 2** Do not operate the buttons with wet hand. It may cause electric shock.
- 3** For safety, turn the circuit breaker off when not using the unit for an extended period of time.
- 4** Check the outdoor unit mounting rack periodically for wear and to make sure it is firmly in place.
- 5** Do not put anything on the outdoor unit nor stand on it. The object or the person may fall down or drop, causing injury.
- 6** This unit is designed for residential use. Do not use for other applications such as in a kennel or greenhouse to feed animals or grow plants.
- 7** Do not place a vessel with water on the unit. If water penetrates into the unit, electrical insulations may deteriorate and cause electric shock.
- 8** Do not block the air inlets or outlets of the unit. It may cause performance issues and technical problems.
- 9** Stop the operation and turn the circuit breaker off before performing any maintenance or cleaning. A fan is rotating inside the unit and you may get injured.
- 10** Do not splash or pour water directly on the unit. Water can cause electrical shock or equipment damage.
- 11** This appliance is not intended for use by young children or infirm persons without supervision. Young children should be supervised to ensure that they do not play with the appliance.





CAUTIONS FOR LOCATION/INSTALLATION

- Make sure to connect the air conditioner to power supply of the rated voltage and frequency. Use of a power supply with improper voltage and frequency can result in equipment damage and possible fire.
- Do not install the unit in a place where inflammable gas may leak. It may cause fire. Install the unit in a place with minimal dust, fumes and moisture in the air.
- Arrange the drain hose to ensure smooth drainage. Insufficient drainage may cause wetting of the room, furniture etc.
- Make sure a leak breaker or a circuit breaker is installed, depending on the installation location, to avoid electrical shock.

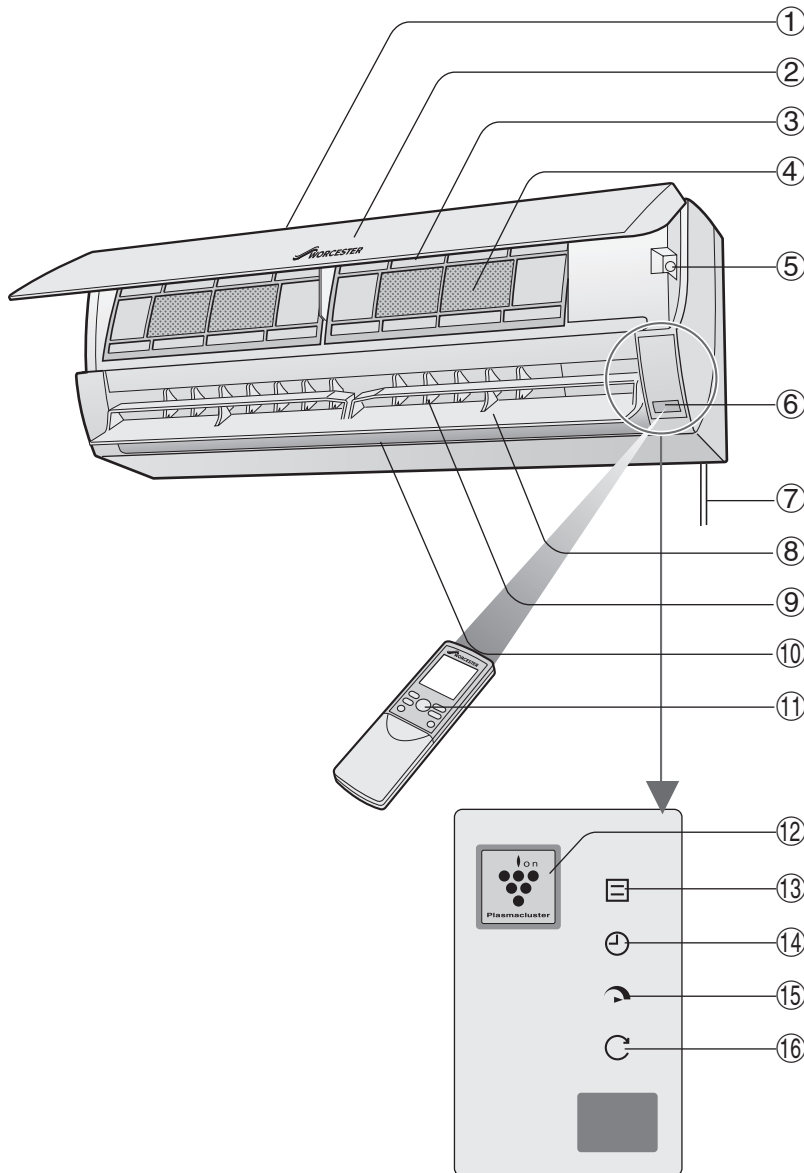
PART NAMES

INDOOR UNIT



- ① Inlet (Air)
- ② Open Panel
- ③ Air Filter
- ④ Air Purifying Filter
- ⑤ AUX Button
- ⑥ Receiver Window
- ⑦ Power Supply Cord
- ⑧ Vertical Adjustment Louvre
- ⑨ Horizontal Adjustment Louvre
- ⑩ Outlet (Air)
- ⑪ Remote Control
- ⑫ PLASMACLUSTER Lamp (blue)
- ⑬ OPERATION Lamp (green )
- ⑭ TIMER Lamp (orange )
- ⑮ FULL POWER Lamp (green )
- ⑯ SELF CLEAN Lamp (green )

OUTDOOR UNIT

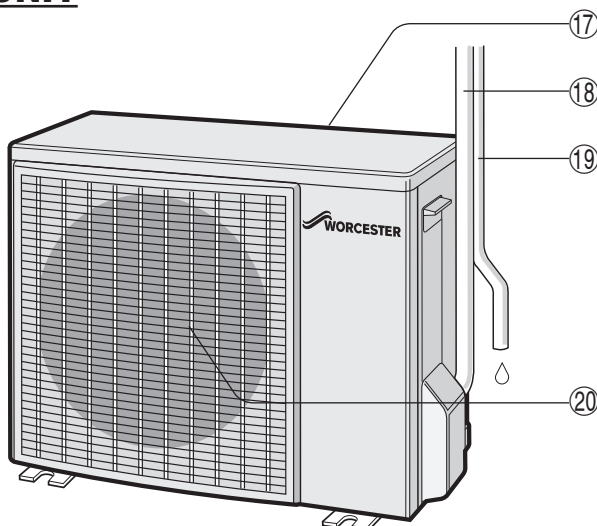



- ⑰ Inlet (Air)
- ⑱ Refrigerant Tube and Interconnecting Cord
- ⑲ Drainage Hose
- ⑳ Outlet (Air)

NOTE:

Actual units might vary slightly from those shown above.

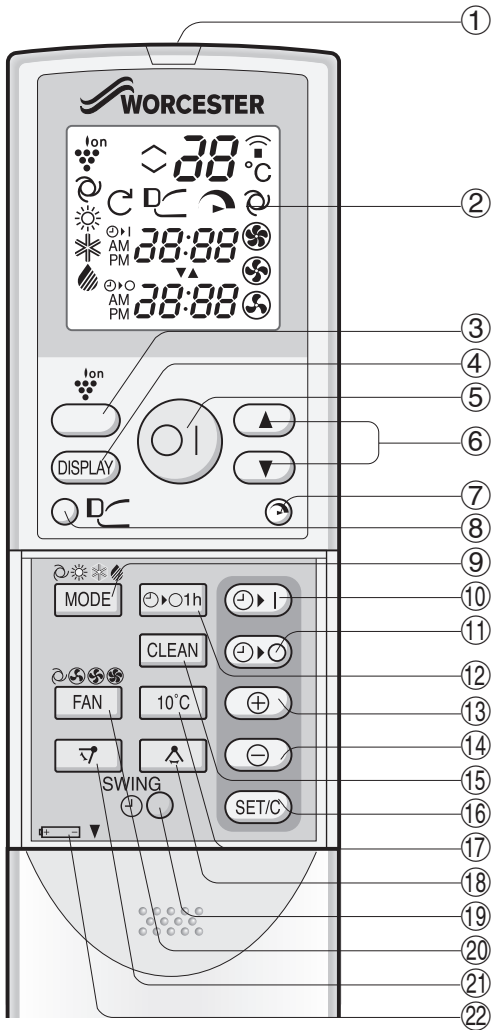
REMOTE CONTROL







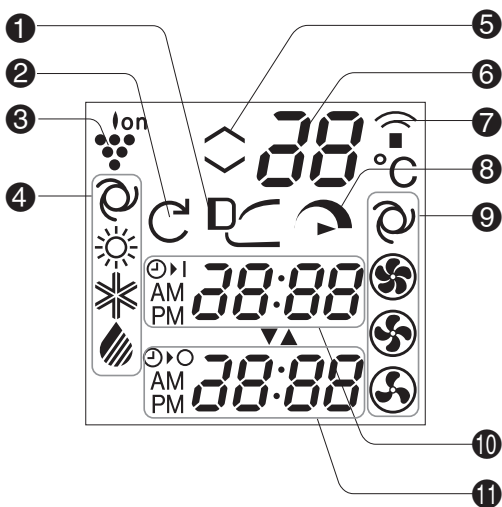



- ① TRANSMITTER
- ② DISPLAY (Liquid Crystal Display)
- ③ PLASMACLUSTER Button
- ④ DISPLAY Button
- ⑤ ON/OFF Button
- ⑥ THERMOSTAT Button
- ⑦ FULL POWER Button
- ⑧ PROGRESSIVE AIRFLOW Button
- ⑨ MODE Button
- ⑩ TIMER ON Button (for setting the timer)
- ⑪ TIMER OFF Button (for setting the timer)
- ⑫ ONE-HOUR OFF TIMER Button
- ⑬ TIME ADVANCE Button
- ⑭ TIME REVERSE Button
- ⑮ SELF CLEAN Button
- ⑯ TIMER SET/CANCEL Button
- ⑰ 10°C Button
- ⑱ SWING Button ( : horizontal direction)
- ⑲ CLOCK Button
- ⑳ FAN Button
- ㉑ SWING Button ( : vertical direction)
- ㉒ Indicates battery compartment is below this mark

L.C.D. REMOTE CONTROL DISPLAY



- ① PROGRESSIVE AIRFLOW Symbol
- ② SELF CLEAN Symbol
- ③ PLASMACLUSTER Symbol
- ④ MODE Symbols

 : AUTO	 : COOL
 : HEAT	 : DRY
- ⑤ Thermostat setting for AUTO and DRY modes
- ⑥ TEMPERATURE Indicator
- ⑦ TRANSMITTING Symbol
- ⑧ FULL POWER Symbol
- ⑨ FAN SPEED Symbols

 : AUTO	 : LOW
 : HIGH	 : SOFT
- ⑩ TIMER ON Indicator/CLOCK
Indicates the on timer preset time or current time.
- ⑪ TIMER OFF Indicator
Indicates the preset time for off timer or one-hour off timer.

USING THE REMOTE CONTROL

LOADING BATTERIES

Use two size-AAA (R03) batteries.

- 1 Remove the remote control cover.**
- 2 Insert batteries in the compartment, making sure the \oplus and \ominus polarities are correctly aligned.**
 - The display indicates “AM 6:00” when batteries are properly installed.
- 3 Reinstall the cover.**

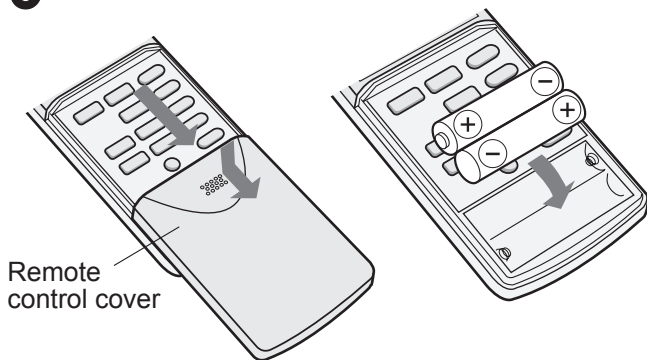

NOTE:

- The battery life is approximately one year in normal use.
- When you replace the batteries, always change both batteries, and make sure they are the same type.
- If the remote control does not operate properly after replacing the batteries, take out the batteries and reinstall them again after 30 seconds.
- If you will not be using the unit for a long time, remove the batteries from the remote control.

HOW TO USE THE REMOTE CONTROL

Point the remote control towards the unit's signal receiver window and press the desired button. The unit generates a beep when it receives the signal.

- Make sure there is no curtain or other object between the remote control and the unit.
- The remote control can send signals from up to 7 metres away.

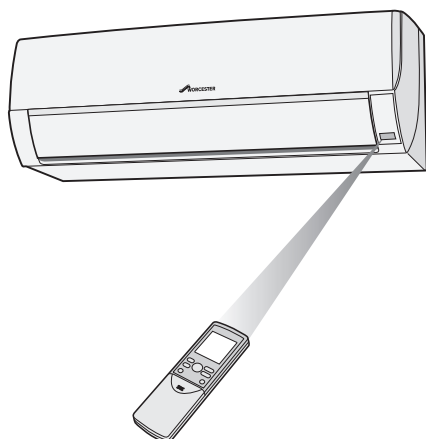

CAUTION:

- Do not allow the signal receiver window to receive strong direct sunlight, since it can adversely affect its operation. If the signal receiver window is exposed to direct sunlight, close a curtain to block the light.
- Using a fluorescent lamp with a quick starter in the same room may interfere with transmission of the signal.
- The unit can be affected by signals transmitted from the remote control of a television, VCR or other equipment used in the same room.
- Do not leave the remote control in direct sunlight or near a heater. Also, protect the unit and remote control from moisture and shock which can discolour or damage them.

SET CURRENT CLOCK TIME

There are two clock modes: 12-hour mode and 24-hour mode.

Example: 5 o'clock in the afternoon

Clock	Display
12-hour mode	PM 5:00
24-hour mode	17:00

- 1 To set to the 12-hour mode, press the CLOCK button once in the first step. To set to the 24-hour mode, press the CLOCK button twice in the first step.**
- 2 Press the TIME ADVANCE or REVERSE button to set the current time.**
 - Keep the button pressed to advance or reverse the time display quickly.
- 3 Press the SET/C button.**
 - The colon (:) blinks to indicate that the clock is functioning.

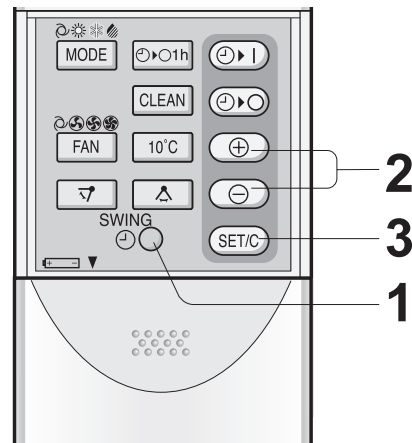

NOTE:

- The current time cannot be set when the timer is operating.

SETTING AIR PURIFYING FILTER

The air purifying filters are packed as accessory of this unit. During operation of the air conditioner, the filters remove dust and tobacco smoke from the air and discharges clean air.

1 Take out the air filters.

- ① Open the open panel.
- ② Push the air filters up slightly to unlock them.
- ③ Pull the air filters down to remove them.

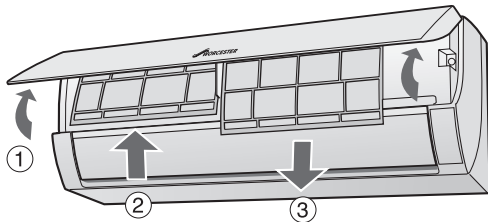

2 Set the air purifying filter under the filter stoppers located on the air filter.

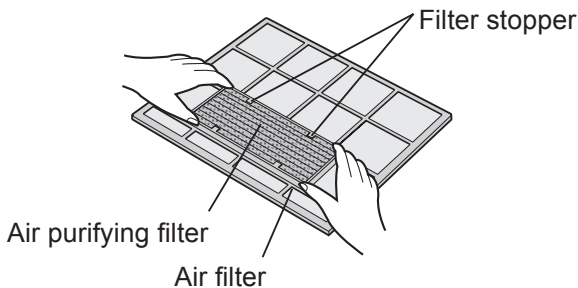

3 Reinstall the air filters.

- ① Reinstall the air filters in the original positions.
- ② Close the open panel.
- ③ Push the arrow-marked of the panel firmly to lock it in place.

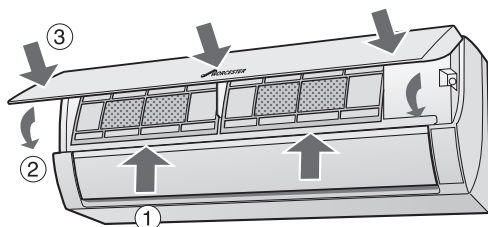

Precautions:

- The filters are sealed in a plastic bag to keep their dust collection effect. Do not open the bag until using the filters. (Otherwise the filters life may get shorter.)
- Do not expose the filters to direct sunlight. (Otherwise they may deteriorate.)

TIPS ON SAVING ENERGY

Below are some simple ways to save energy when you use your air conditioner.

SET THE CORRECT TEMPERATURE

- Setting the thermostat 1°C higher than the desired temperature in the COOL mode and 2°C lower in the HEAT mode will save approximately 10 percent in power consumption.
- Setting the temperature lower than necessary during cooling operation will result in increased power consumption.

BLOCK DIRECT SUNLIGHT AND PREVENT DRAFTS

- Blocking direct sunlight during cooling operation will reduce power consumption.
- Close the windows and doors during cooling and heating operations.

SET PROPER AIR FLOW DIRECTION TO OBTAIN THE BEST AIR CIRCULATION

KEEP FILTER CLEAN TO ENSURE THE MOST EFFICIENT OPERATION

MAKE MOST OF THE TIMER OFF FUNCTION

DISCONNECT THE POWER CORD WHEN THE UNIT IS NOT USED FOR AN EXTENDED PERIOD OF TIME

- The indoor unit still consumes a small amount of power when it is not operating.

AUXILIARY MODE

Use this mode when the remote control is not available.

TO TURN ON

Lift the open panel of the indoor unit and press the AUX button.

- The green OPERATION lamp () on the unit will light and the unit will start operating in the AUTO mode.
- The fan speed and temperature setting are set to AUTO.

TO TURN OFF

Press the AUX button again.

- The green OPERATION lamp () on the unit will turn off.

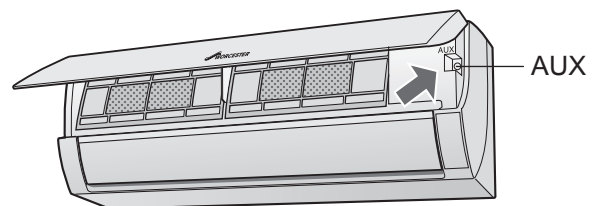

NOTE:

- If the AUX button is pressed during normal operation, the unit will turn off.

BASIC OPERATION

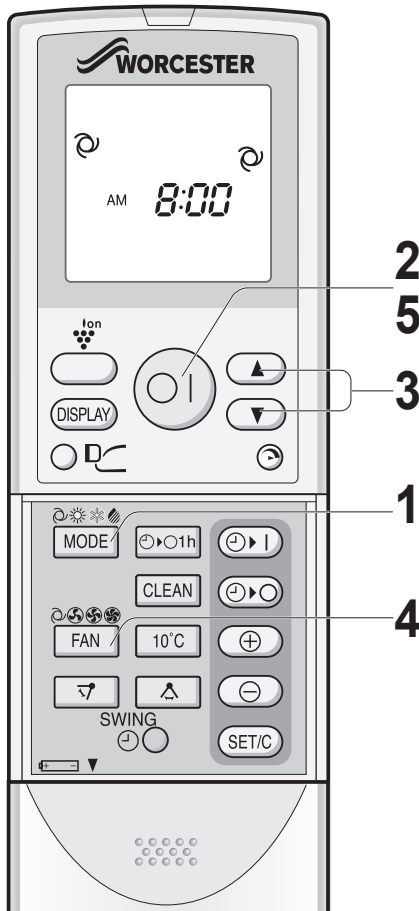

1 Press the **MODE** button to select the operation mode.

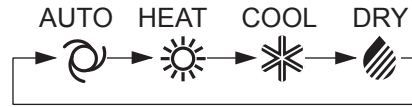

2 Press the **ON/OFF** button to start operation.

- The green OPERATION lamp () on the unit will light.

3 Press the **THERMOSTAT** button to set the desired temperature.

AUTO/DRY MODE

- The temperature can be changed in 1°C increments within the range of 2°C higher to 2°C lower from the temperature automatically determined by the air conditioner.

(Example: 1°C higher)



(Example: 2°C lower)

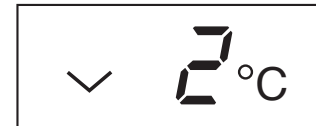

TIPS ABOUT AUTO MODE

In the AUTO mode, the temperature setting and mode are automatically selected according to the room temperature and outdoor temperature when the unit is turned on.

Modes and Temperature Settings

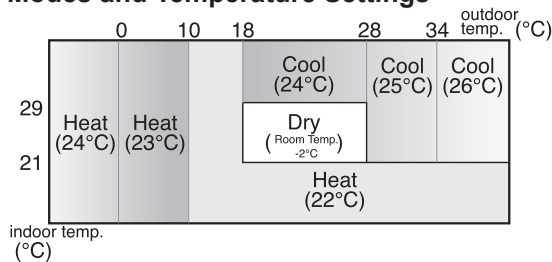

The figures in () are temperature settings

During operation, if the outdoor temperature changes, the temperature settings will automatically slide as shown in the chart.

MODE CHANGEOVER

During seasons when you need COOLING at daytime and HEATING at night, or if the room temperature should become extremely higher than the temperature setting, due to supplementary heating equipment, the mode will automatically switch between HEAT and COOL mode to keep the comfortable room temperature.

COOL/HEAT MODE

- The temperature can be set within the range of 18 to 32°C.

4 Press the **FAN** button to set the desired fan speed.



- In the DRY mode, the fan speed is preset to AUTO and cannot be changed.

5 To turn off the unit, press the **ON/OFF** button again.

- The green OPERATION lamp () on the unit will turn off.

ADJUSTING THE AIR FLOW DIRECTION

VERTICAL AIR FLOW DIRECTION

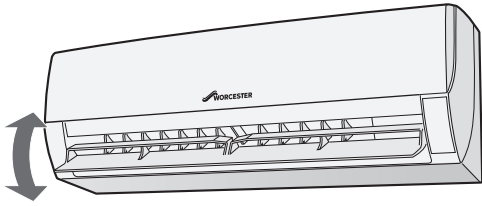

1 Press the SWING button() on the remote control once.

- The vertical adjustment louvre will swing continuously.

2 Press the SWING button() again when the vertical adjustment louvre is at the desired position.

- The louvre will stop moving within the range shown in the diagram.

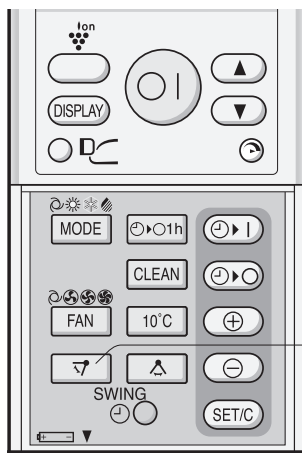

1
2

HORIZONTAL AIR FLOW DIRECTION

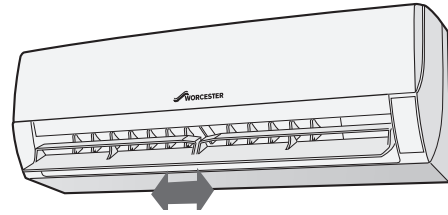

1 Press the SWING button() on the remote control once.

- The horizontal adjustment louvres will swing continuously.

2 Press the SWING button() again when the horizontal adjustment louvres are at the desired position.

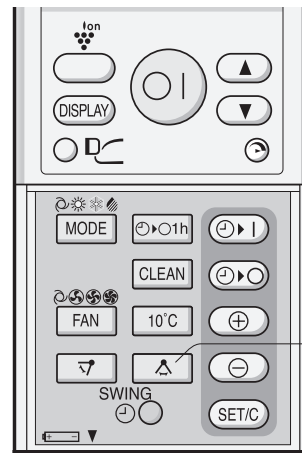

1
2

Adjustment range

COOL and DRY modes HEAT mode

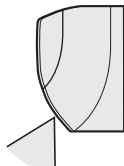
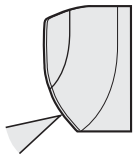

NOTE:

- The adjusted position will be memorized and will be automatically set to the same position when operated the next time.
- The adjustment range is narrower the SWING range in order to prevent condensation from dripping.

CAUTION:

Never attempt to adjust the louvres manually.

- Manual adjustment of the louvres can cause the unit to malfunction.
- When the vertical adjustment louvre is positioned at the lowest position in the COOL or DRY mode for an extended period of time, condensation may result.

PROGRESSIVE AIRFLOW

Press the **PROGRESSIVE AIRFLOW** button during cooling or dry operation when you do not want to feel cold air. Vertical adjustment louvre is set obliquely upward to deliver cool air to the ceiling.

Press the button during heating operation. Vertical adjustment louvre is set downward to deliver the warm air down to the floor.

1 During operation, press the **PROGRESSIVE AIRFLOW** button.



- The remote control will display “”.



FULL POWER OPERATION

In this operation, the air conditioner works at the maximum power and optimum louvre direction to make the room cool or warm rapidly.

1 During operation, press the **FULL POWER** button.

- The remote control will display “”.
- The temperature display will go off.
- The green **FULL POWER** lamp () on the unit will light up.
- The vertical adjustment louvre will be set obliquely downward.



TO CANCEL

Press the **PROGRESSIVE AIRFLOW** button again.

NOTE:

- The **PROGRESSIVE AIRFLOW** setting is cancelled when you press **FULL POWER** button while **PROGRESSIVE AIRFLOW** is set.
- If you want **PROGRESSIVE AIRFLOW** operation in **FULL POWER** mode, press **PROGRESSIVE AIRFLOW** button during **FULL POWER** operation.

TO CANCEL

Press the **FULL POWER** button again.

- The **FULL POWER** operation will also be cancelled when the operation mode is changed, or when the unit is turned off.
- The green **FULL POWER** lamp () on the unit will turn off.
- The vertical adjustment louvre will return to the original direction.

NOTE:

- The air conditioner will operate at “Extra HIGH” fan speed for 5 minutes, and then shift to “HIGH” fan speed.
- You can not set the temperature or fan speed during the **FULL POWER** operation.
- To turn off the **FULL POWER** lamp, press the **DISPLAY** button.

PLASMACLUSTER OPERATION

Plasmacluster Ions released into the room will reduce some airborne mold.

1 During operation, press the PLASMACLUSTER button.

- The remote control will display “”.
- The blue PLASMACLUSTER lamp on the unit will light up.

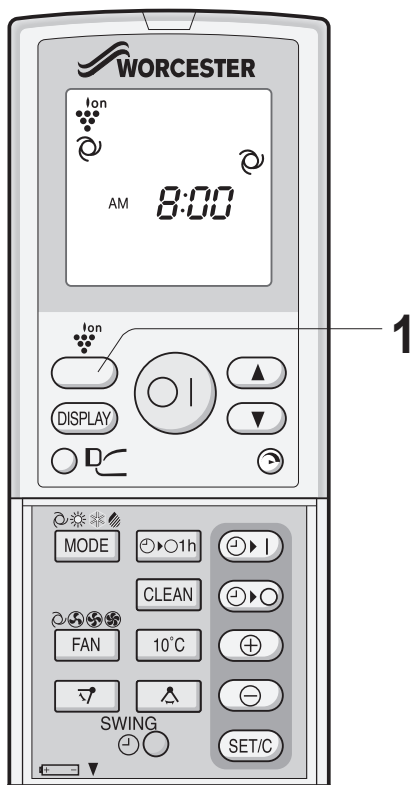

TO CANCEL

Press the PLASMACLUSTER button again.

- The blue PLASMACLUSTER lamp on the unit will turn off.

NOTE:



- Use of the PLASMACLUSTER operation will be memorized, and it will be activated the next time you turn on the air conditioner.
- To turn off the PLASMACLUSTER lamp, press the DISPLAY button.
- To perform the PLASMACLUSTER operation in fan only mode, press the PLASMACLUSTER button while the unit is not operating. The mode symbol of the remote control will go off and the fan speed can not be set AUTO.

SELF CLEAN OPERATION

SELF CLEAN operation will reduce the growth mold fungus with Plasmacluster ions, and dry inside of the air conditioner unit.

Utilize the operation at seasonal change over terms.

1 Press the SELF CLEAN button when the unit is not operating.

- The remote control displays “”.
- The green OPERATION lamp (), the green SELF CLEAN lamp () and the blue PLASMACLUSTER lamp on the unit will light up.
- The unit will stop operation after forty minutes.

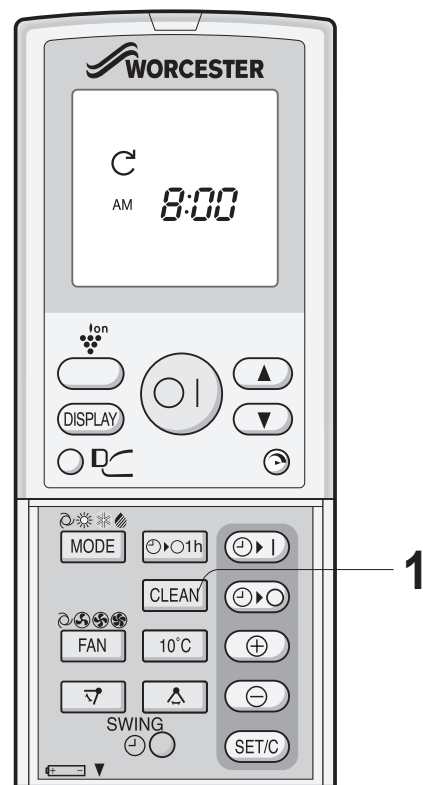

TO CANCEL

Press the SELF CLEAN button.

Alternatively, turn the unit off by pressing the ON/OFF button.

- The green OPERATION lamp (), the green SELF CLEAN lamp () and the blue PLASMACLUSTER lamp on the unit will turn off.

NOTE:

- You cannot set the temperature, fan speed, air flow direction or timer setting during the SELF CLEAN operation.
- Mold fungus already grown can not be eliminated by this operation.

ONE-HOUR OFF TIMER

When the ONE-HOUR OFF TIMER is set, the unit will automatically turn off after one hour.

1 Press the ONE-HOUR OFF TIMER button.

- The remote control displays “ $\odot \circ \text{1h}$ ”.
- The orange TIMER lamp (\odot) on the unit will light up.
- The unit will stop operating after one hour.

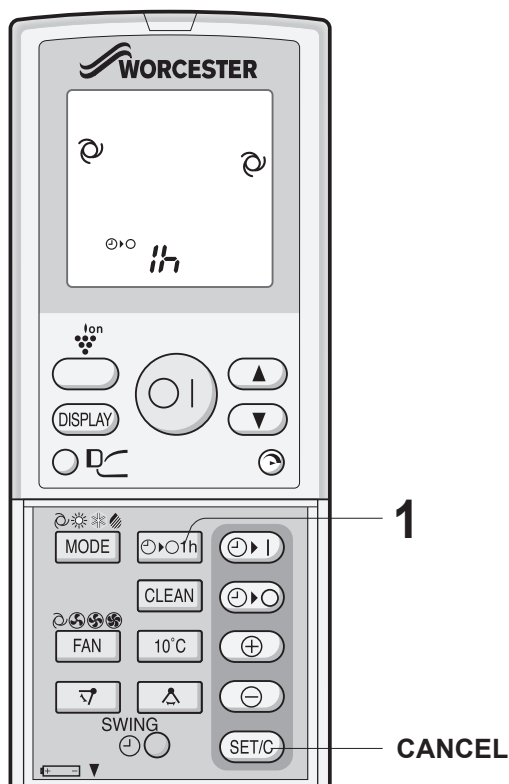

TO CANCEL

Press the TIMER CANCEL (SET/C) button.

- The orange TIMER lamp (\odot) on the unit will turn off.

Alternatively, turn the unit off by pressing the ON/OFF button.

- The green OPERATION lamp (\square) and the orange TIMER lamp (\odot) on the unit will turn off.

NOTE:

- The ONE-HOUR OFF TIMER operation has priority over TIMER ON and TIMER OFF operations.
- If the ONE-HOUR OFF TIMER is set while the unit is not operating, the unit will operate for an hour at the formerly set condition.
- If you wish to operate the unit for another hour before the ONE-HOUR OFF TIMER is activated, press the ONE-HOUR OFF TIMER button again during operation.
- If TIMER ON and/or TIMER OFF are set, TIMER CANCEL button cancels every setting.

TIMER OPERATION

TIMER OFF

- 1 Press the TIMER OFF ($\odot \circ$) button.
- 2 The TIMER OFF indicator will blink; press the TIME ADVANCE or REVERSE button to set the desired time.
(The time can be set in 10-minute increments.)
- 3 Point the remote control at the receiver window on the unit and press the TIMER SET (SET/C) button.
 - The orange TIMER lamp (\odot) on the unit will light.
 - The unit will generate a beep when it receives the signal.

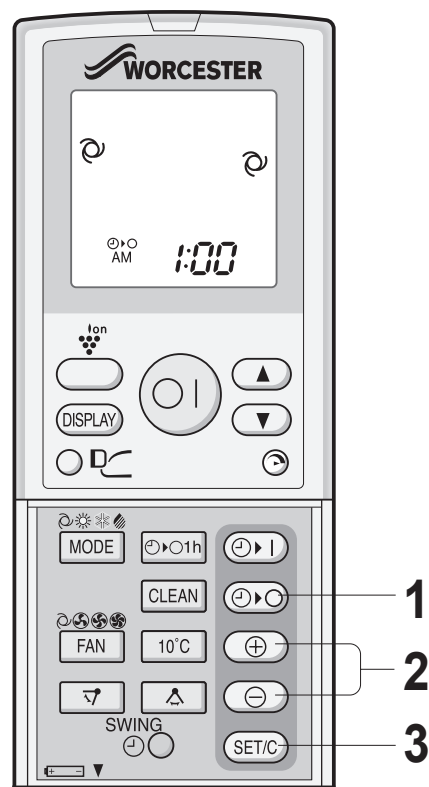

TIPS ABOUT TIMER OFF OPERATION

When the TIMER OFF mode is set, the temperature setting is automatically adjusted to prevent the room from becoming excessively hot or too cold while you sleep. (Auto Sleep function) The Auto Sleep function will not activate during the AUTO mode.

COOL/DRY MODE:



- One hour after the time operation begins, the temperature setting rises 1°C higher than the original temperature setting.

HEAT MODE:

- One hour after the timer operation begins, the temperature setting drops 3°C lower than the original temperature setting.

Before setting the timer, make sure the clock is properly set with the current time.

TIMER ON

- 1** Press the **TIMER ON** () button.
- 2** The **TIMER ON** indicator will blink; press the **TIME ADVANCE** or **REVERSE** button to set the desired time.
(The time can be set in 10-minute increments.)
- 3** Point the remote control at the receiver window on the unit and press the **TIMER SET (SET/C)** button.
 - The orange **TIMER** lamp () on the unit will light.
 - The unit will generate a beep when it receives the signal.
- 4** Select the operation condition.

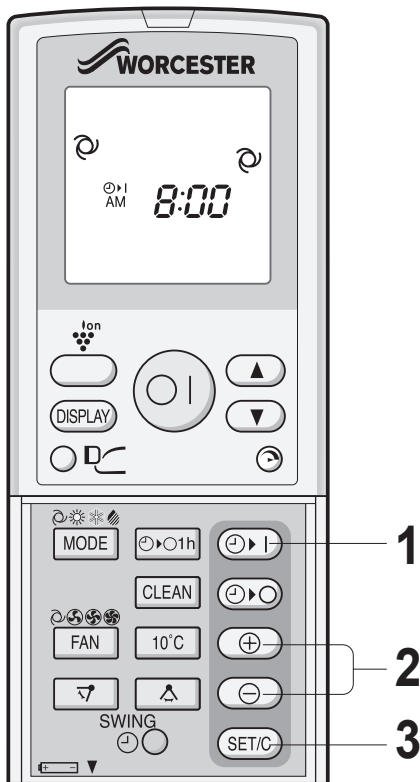

NOTE:

- The unit will turn on prior to the set time to allow the room to reach the desired temperature by the programmed time. (Awaking function)

TO CANCEL TIMER MODE

Press the **TIMER CANCEL (SET/C)** button.

- The orange **TIMER** lamp () on the unit will turn off.
- The current clock time will be displayed on the remote control.

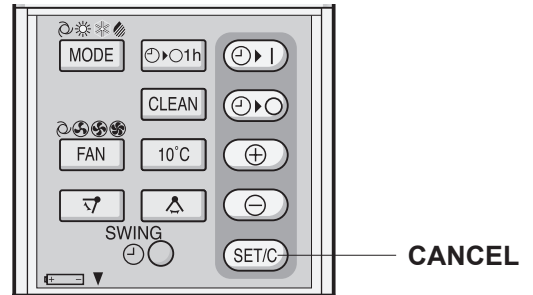

NOTE:

- If any **TIMER ON**, **TIMER OFF** and **ONE-HOUR OFF TIMER** are set, the **TIMER CANCEL** button cancels all settings.

TO CHANGE TIME SETTING



Cancel the **TIMER** setting first, then set it again.

COMBINED USE OF ON AND OFF TIMERS

You can use the **ON** and **OFF** timers in combination.

Example:

To stop operation at 11:00 p.m. and resume operation to bring the room temperature to the desired level by 7:00 a.m.

- 1** Set the **TIMER OFF** to 11:00 p.m. during operation.
- 2** Set the **TIMER ON** to 7:00 a.m.
The arrow ( or ) between the **TIMER ON** indicator and the **TIMER OFF** indicator shows which timer will activate first.

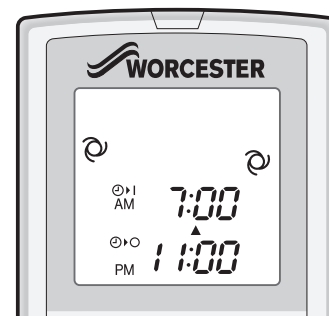

NOTE:

- You cannot programmed the **ON-TIMER** and **OFF-TIMER** to operate the unit at different temperatures or other settings.
- Either timer can be programmed to activate prior the other.

10°C OPERATION

Heating operation with 10°C set temperature will be performed.

- 1** Press the **MODE** button and select **HEAT** mode.
- 2** Press the **ON/OFF** button to start **HEAT** operation.
- 3** Press the **10°C** button.
 - The remote control will display “ 10°C ” .

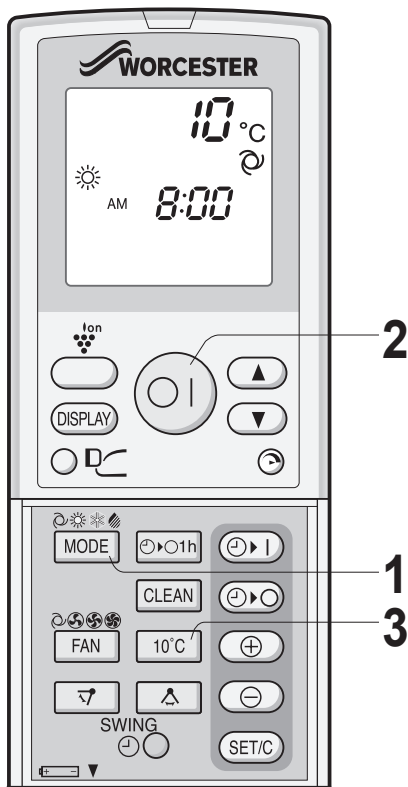

TO CANCEL

Press the **10°C** button again.

- 10°C operation will also be cancelled when the operation mode is changed, or when the unit is turned off.

NOTE:

- 10°C operation will not be available with heating operation automatically selected by AUTO mode.

ADDITIONAL NOTES ON OPERATION

OPERATING TEMPERATURE RANGE

		INDOOR TEMP.	OUTDOOR TEMP.
COOLING	upper limit	32°C	43°C
	lower limit	21°C	-10°C
HEATING	upper limit	27°C	24°C
	lower limit	-	-20°C

- The built-in protective device may prevent the unit from operating when used out of this range.
- Condensation may form on the air outlet if the unit operates continuously in the COOL or DRY mode when humidity is over 80 percent.

WHEN POWER FAILURE OCCURS

This air conditioner has a memory function to store settings when a power failure occurs. After power recovery, the unit will automatically re-start in the same settings which were active before the power failure, except for timer settings. If the timers were set before a power failure, they will need to be re-set after power recovery.

PREHEATING FUNCTION

In the HEAT operation, the indoor fan may not start for two to five minutes after the unit is turned on to prevent cold air from blowing out of the unit.

DE-ICING FUNCTION

- When ice forms on the heat exchanger in the outdoor unit during the HEAT operation, an automatic de-icer provides heat for about 5 to 10 minutes to remove the ice. During de-icing, the inside and outside fans stop operating.
- After de-icing is completed, the unit automatically resumes operation in the HEAT mode.

HEATING EFFICIENCY

- The unit employs a heat pump that draws heat from the outside air and releases it into the room. The outside air temperature therefore greatly affects the heating efficiency.
- If the heating efficiency is reduced due to low outside temperatures, use an additional heater.
- It takes time to warm up and heat the entire room because of the forced air circulation system.

MAINTENANCE

Be sure to disconnect the power cord from the wall outlet or turn off the circuit breaker before performing any maintenance.

CLEANING THE FILTERS

The air filters should be cleaned every two weeks.

- 1 Turn off the unit.
- 2 Remove the filters.
 - ① Lift the open panel.
 - ② Push the air filters up slightly to unlock them.
 - ③ Pull the air filters down to remove them.

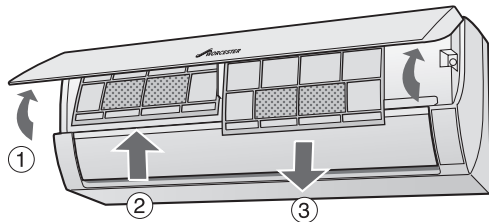

- 3 Take off the air purifying filters from the air filters.
- 4 Clean the filters.

Use a vacuum cleaner to remove dust. If the filters are dirty, wash them with warm water and a mild detergent. Dry filters in the shade before reinstalling.

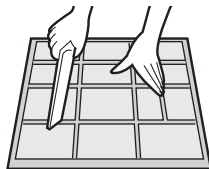

- 5 Reinstall the air purifying filters.
- 6 Reinstall the filters.

- ① Reinstall the filters in the original positions.
- ② Close the open panel.
- ③ Push the arrow-marked of the panel firmly to lock it in place.

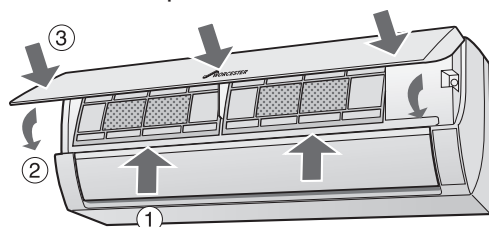

CLEANING THE UNIT AND THE REMOTE CONTROL

- Wipe them with a soft cloth.
- Do not directly splash or pour water on them. It can cause electrical shock or equipment damage.
- Do not use hot water, thinner, abrasive powders or strong solvents.

MAINTENANCE AFTER AIR CONDITIONER SEASON

- 1 Operate the unit in the SELF CLEAN operation to allow the mechanism to thoroughly dry.
- 2 Stop the operation and unplug the unit. Turn off the circuit breaker, if you have one exclusively for the air conditioner.
- 3 Clean the filters, then reinstall them.

MAINTENANCE BEFORE AIR CONDITIONER SEASON

- 1 Make sure that the air filters are not dirty.
- 2 Make sure that nothing obstructs the air inlet or outlet.

CHANGING THE AIR PURIFYING FILTER

The filters should be changed every 3 ~ 6 months

- 1 Remove the air filters.
- 2 Change the air purifying filters.
 - ① Take off the old air purifying filters from the air filters.
 - ② Set the new air purifying filters, under the filter stoppers located on the air filters.

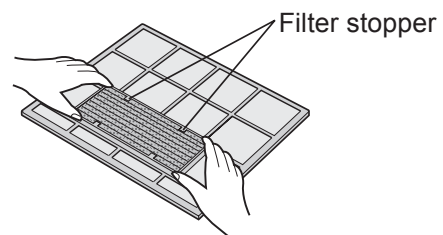

- 3 Reinstall the air filters.

NOTE:

- The dirty air purifying filters are not washable for reuse. The new filters are available at your nearest dealer.

Disposal of Filters

Please dispose of replaced filters according to the local disposal laws and regulations.

AIR PURIFYING filter materials

Filter: Polypropylene

Frame: Polyester

BEFORE CALLING FOR SERVICE

The following conditions do not denote equipment malfunctions

UNIT DOES NOT OPERATE

The unit will not operate if it is turned on immediately after it is turned off. The unit will not operate immediately after the mode is changed. This is to protect the internal mechanisms. Wait 3 minutes before operating the unit.

UNIT DOES NOT SEND OUT WARM AIR

The unit is preheating or de-icing.

ODORS

Carpet and furniture odors that entered into the unit may be sent out from the unit.

CRACKING NOISE

The unit may produce a cracking noise. This sound is generated by the friction of the front panel and other components expanding or contracting due to a temperature change.

A LOW BUZZING NOISE EMITTED

This is a sound emitted when the unit is generating Plasmacluster ions.

SWISHING NOISE

The soft, swishing noise is the sound of the refrigerant flowing inside the unit.

WATER VAPOUR

- In the COOL and DRY operation, water vapour can sometimes be seen at the air outlet due to the difference between the room air temperature and the air discharged by the unit.
- In the HEAT operation, water vapour may flow out of the outdoor unit during de-icing.

THE OUTDOOR UNIT DOES NOT STOP

After stopping the operation, the outdoor unit will rotate its fan for about a minute to cool down the unit.

ODOR EMITTED FROM THE PLASMACLUSTER AIR OUTLET

This is the smell of ozone generated from the Plasmacluster Ion generator. The ozone concentration is very small, posing no adverse effect on your health. The ozone discharged into the air rapidly decomposes, and its density in the room will not increase.

If the unit appears to be malfunctioning, check the following points before calling for service.

IF THE UNIT FAILS TO OPERATE

Check to see if the circuit breaker has tripped or the fuse has blown.

IF THE UNIT FAILS TO COOL (OR HEAT) THE ROOM EFFECTIVELY

- Check the filters. If dirty, clean them.
- Check the outdoor unit to make sure nothing is blocking the air inlet or outlet.
- Check the thermostat is proper setting.
- Make sure windows and doors are closed tightly.
- A large number of people in the room can prevent the unit from achieving the desired temperature.
- Check whether any heat-generating appliances are operating in the room.

IF THE UNIT FAILS TO RECEIVE THE REMOTE CONTROL SIGNAL

- Check whether the remote control batteries have become old and weak.
- Try to send the signal again with the remote control pointed properly towards the unit's signal receiver window.
- Check whether the remote control batteries are installed with the polarities properly aligned.

Please call for service when OPERATION lamp, TIMER lamp and/or PLASMACLUSTER lamp on the unit blink.



Worcester, Bosch Group is a brand name of Bosch Thermotechnology Ltd.
Cotswold Way, Warndon,
Worcester, WR4 9SW
Tel 01905 754624 Fax: 01905 754619

Worcester, Bosch Group is a brand name of Bosch Thermotechnology Ltd.